



OPERATORS MANUAL FOR Mi-T-M®
WX-0133
Coagulant Addition System



CAUTION
RISK OF INJURY!

READ MANUAL BEFORE OPERATING!

This manual is important and must remain with the unit when you sell it!

Contents

INTRODUCTION	3
PACKAGE CONTENTS	4
SPECIFICATIONS	4
IMPORTANT SAFETY WARNINGS.....	5
INSTALLATION	10
MAIN ASSEMBLY WTA-300/600.....	14
PUMP ASSEMBLY 3-0435	16
WIRING SCHEMATIC SINGLE PHASE.....	18
WIRING DIAGRAM SINGLE PHASE	19
WIRING SCHEMATIC THREE PHASE	20
WIRING DIAGRAM THREE PHASE	21

WARNING

 **WARNING:** This product can expose you to chemicals including Lead, which is known to the State of California to cause cancer and birth defects or other reproductive harm. For more information go to www.P65Warnings.ca.gov

WARNING

 **WARNING:** This product can expose you to chemicals including carbon monoxide, which is known to the State of California to cause birth defects or other reproductive harm. For more information go to www.P65Warnings.ca.gov

INTRODUCTION

Congratulations on the purchase of your new Mi-T-M Coagulant system! You can be assured your Mi-T-M Coagulant system was constructed and designed with quality and performance in mind. Each component has been rigorously tested to ensure the highest level of acceptance.

This operator's manual was compiled for your benefit. By reading and following the simple safety, installation, operation, maintenance and troubleshooting steps described in this manual, you will receive years of trouble free operation from your new Mi-T-M Coagulant system. The contents of this manual are based on the latest product information available at the time of publication. Mi-T-M reserves the right to make changes in price, color, materials, equipment, specifications or models at any time without notice.

! important !

These paragraphs are surrounded by a "SAFETY ALERT BOX". This box is used to designate and emphasize Safety Warnings that must be followed when operating this Coagulant system. Accompanying the Safety Warnings are "signal words" which designate the degree or level of hazard seriousness. The "signal words" used in this manual are as follows:

DANGER: Indicates an imminently hazardous situation which, if not avoided, **WILL result in death or serious injury.**

WARNING: Indicates a potentially hazardous situation which, if not avoided, **COULD result in death or serious injury.**

CAUTION: Indicates a potentially hazardous situation which, if not avoided **MAY result in minor or moderate injury.**



The symbol set to the left of this paragraph is a "Safety Alert Symbol". This symbol is used to call attention to items or procedures that could be dangerous to you or other persons using this equipment.

ALWAYS PROVIDE A COPY OF THIS MANUAL TO ANYONE USING THIS EQUIPMENT. READ ALL INSTRUCTIONS BEFORE OPERATING THIS COAGULANT ADDITION SYSTEM AND ESPECIALLY POINT OUT THE "SAFETY WARNINGS" TO PREVENT THE POSSIBILITY OF PERSONAL INJURY TO THE OPERATOR.

Inspect for signs of obvious or concealed freight damage. If damage does exist, file a claim with the transportation company immediately. Be sure that all damaged parts are replaced and that the mechanical and electrical problems are corrected prior to operation of the unit. If you require service, contact Mi-T-M Customer Service.

CUSTOMER SERVICE

CALL OUR TOLL-FREE NUMBER

for the Sales or Service Center nearest you!

800-553-9053

Please have the following information available for all service calls:

1. Model Number
2. Date and Place of Purchase

PACKAGE CONTENTS

Carefully unpack your new Mi-T-M Coagulant Addition system. Check the contents against the packing list. Contact the freight line if a damage claim is required on any component. The following items are the basic equipment sent with your Coagulant Addition system.

1. Main control box
2. Chemical feed/pickup tubes
3. Chemical feed strainer
4. Plumbing assembly
5. 3-Way control switch
6. Chemical pump
7. This manual

SPECIFICATIONS

WX-0133

ELECTRICAL:

120 vac supply
0.3 amp

CHEMICAL FEED RATE:

Adjustable .12-4.6 gallons per hour. Please note this is with chemicals having a viscosity similar to water.



IMPORTANT SAFETY WARNINGS



WARNING: When using this product, basic precautions should always be observed, including the following:
READ ALL SAFETY WARNINGS BEFORE USING COAGULANT ADDITION SYSTEM





HAZARD	POTENTIAL CONSEQUENCE	PREVENTION
<p data-bbox="178 262 535 325">RISK OF ELECTRIC SHOCK OR ELECTROCUTION</p> 	<p data-bbox="560 262 974 493">Serious injury or death could occur if the Coagulant Addition system is not properly grounded. Your Coagulant Addition system is powered by electricity and may cause electric shock or electrocution if not installed properly.</p> <p data-bbox="560 1081 974 1186">Electrical shock may occur if Coagulant Addition system is not operated properly.</p> <p data-bbox="560 1323 974 1417">Serious injury or death may occur if electrical repairs are attempted by unqualified persons.</p>	<p data-bbox="1015 262 1550 357">Installation of this unit, including all electrical connections, must comply with all local, state and national codes.</p> <p data-bbox="1015 367 1550 546">This product must be grounded. Connect to a GFCI circuit breaker when available. If the unit should malfunction or breakdown, grounding provides a path of least resistance for electric current to reduce the risk of electric shock. Do not ground to a gas supply line.</p> <p data-bbox="1015 556 1550 703">Improper connection of the equipment-grounding conductor can result in a risk of electrocution. Check with a qualified electrician or service personnel if you are in doubt as to whether the system is properly grounded.</p> <p data-bbox="1015 714 1550 871">Always be certain the unit is receiving proper voltage (+/- 5% of the voltage listed on the nameplate). Before installing electrical connections, be certain the power switches are in the "OFF" position.</p> <p data-bbox="1015 882 1550 913">Keep all connections dry and off the ground.</p> <p data-bbox="1015 924 1550 1071">Do not touch pump, pump motor, discharge piping or water when the unit is connected to the power supply; regardless of whether the unit is operating correctly or experiencing an operation failure.</p> <p data-bbox="1015 1081 1550 1176">DO NOT allow metal components of the Coagulant Addition system to come in contact with live electrical components.</p> <p data-bbox="1015 1186 1550 1312">Never operate the Coagulant Addition system with safety guards/covers removed or damaged. Ensure all electrical covers are securely in place when unit is operating.</p> <p data-bbox="1015 1323 1550 1449">Any electrical wiring or repairs performed on this Coagulant Addition system should be done by Authorized Service Personnel in accordance with National and Local electrical codes.</p> <p data-bbox="1015 1459 1550 1827">Before opening any electrical enclosure, always shut off the Coagulant Addition system and drain the water. Disconnect the Coagulant Addition system from the power source. If the power disconnect is not in sight, lock it in the open position and tag it to prevent power usage. (Never assume the Coagulant Addition system is safe to work on just because it is not operating, it could restart at any time! Always disconnect from the power source.) Allow the Coagulant Addition system to cool down. Service in a clean, dry, flat area.</p>



IMPORTANT SAFETY WARNINGS

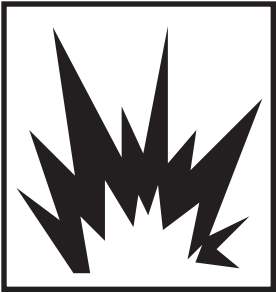

READ ALL SAFETY WARNINGS BEFORE USING COAGULANT ADDITION SYSTEM

HAZARD	POTENTIAL CONSEQUENCE	PREVENTION
<p>RISK OF EXPLOSION OR FIRE</p>  	<p>Serious injury or death could occur from an explosion or fire caused by a system electric spark.</p>	<p>This unit must be placed in an area that is well ventilated, free of flammable vapors, combustible dust, gases or other combustible materials.</p>
<p>RISK OF BURSTING</p> 	<p>Serious injury or death could occur from bursting caused by excessive pressure in the system.</p> <p>Serious injury may occur if attempting to start the Coagulant Addition system when the pump is frozen.</p>	<p>Do not use this Coagulant Addition system to pump flammable material! An explosion could occur from a gas vapor buildup inside the system.</p> <p>In freezing temperatures, the unit must always be warm enough to ensure there is no ice formation in the pump. Do not start the Coagulant Addition system if it has been in a freezing environment without first allowing the pump to thaw.</p>
<p>RISK OF BURNS</p> 	<p>Serious injury may occur from touching the electrical motor. This area can remain hot for some time after the Coagulant Addition is shutdown.</p>	<p>Never allow any part of your body to contact the electrical motor until cooled.</p>
<p>RISK FROM MOVING PARTS</p> 	<p>Serious injury may occur to the operator from moving parts on the Coagulant Addition system.</p>	<p>Do not operate the unit without all protective covers in place.</p> <p>Follow the maintenance instructions specified in the manual.</p>



IMPORTANT SAFETY WARNINGS



READ ALL SAFETY WARNINGS BEFORE USING COAGULANT ADDITION SYSTEM

HAZARD	POTENTIAL CONSEQUENCE	PREVENTION
<p>RISK OF BODILY INJURY</p> 	<p>Injury may occur from the Coagulant Addition System.</p>	<p>DO NOT DRINK THE WATER IN THE Coagulant Addition SYSTEM!! This is non-potable water and is not suitable for consumption.</p> <p>DO NOT allow children to operate this unit.</p> <p>DO NOT overreach or stand on unstable support.</p> <p>Wet surfaces can be slippery, wear protective foot gear and keep good footing and balance at all times.</p> <p>Know how to stop the Coagulant Addition system. Be thoroughly familiar with controls.</p> <p>Before servicing, ALWAYS shut off the Coagulant Addition system.</p>

!SAVE THESE INSTRUCTIONS!

FEATURES VIEW

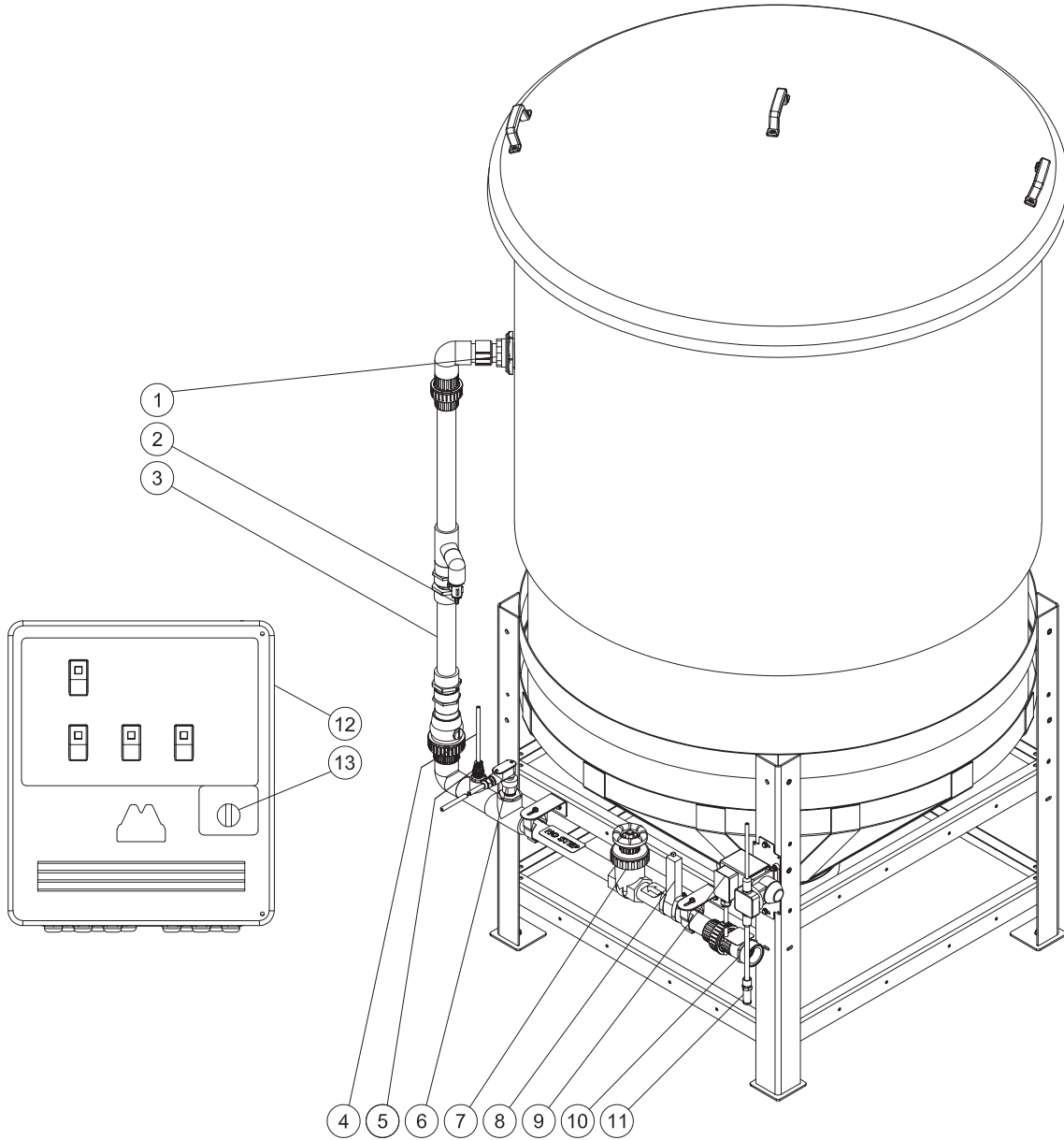

ITEM DESCRIPTION

- | | |
|-----------------------|---------------------------|
| 1. TANK INLET | 8. FLOWMETER |
| 2. SAMPLING VALVE | 9. CHEMICAL PUMP |
| 3. PIPE MIXER | 10. INLET FROM SUMP PUMP |
| 4. INJECTION HOSE | 11. STRAINER/SUCTION HOSE |
| 5. INJECTION VALVE | 12. CONTROL BOX |
| 6. FLOW SWITCH | 13. 3-WAY SELECTOR SWITCH |
| 7. FLOW CONTROL VALVE | |

FIELD WIRING DIAGRAM

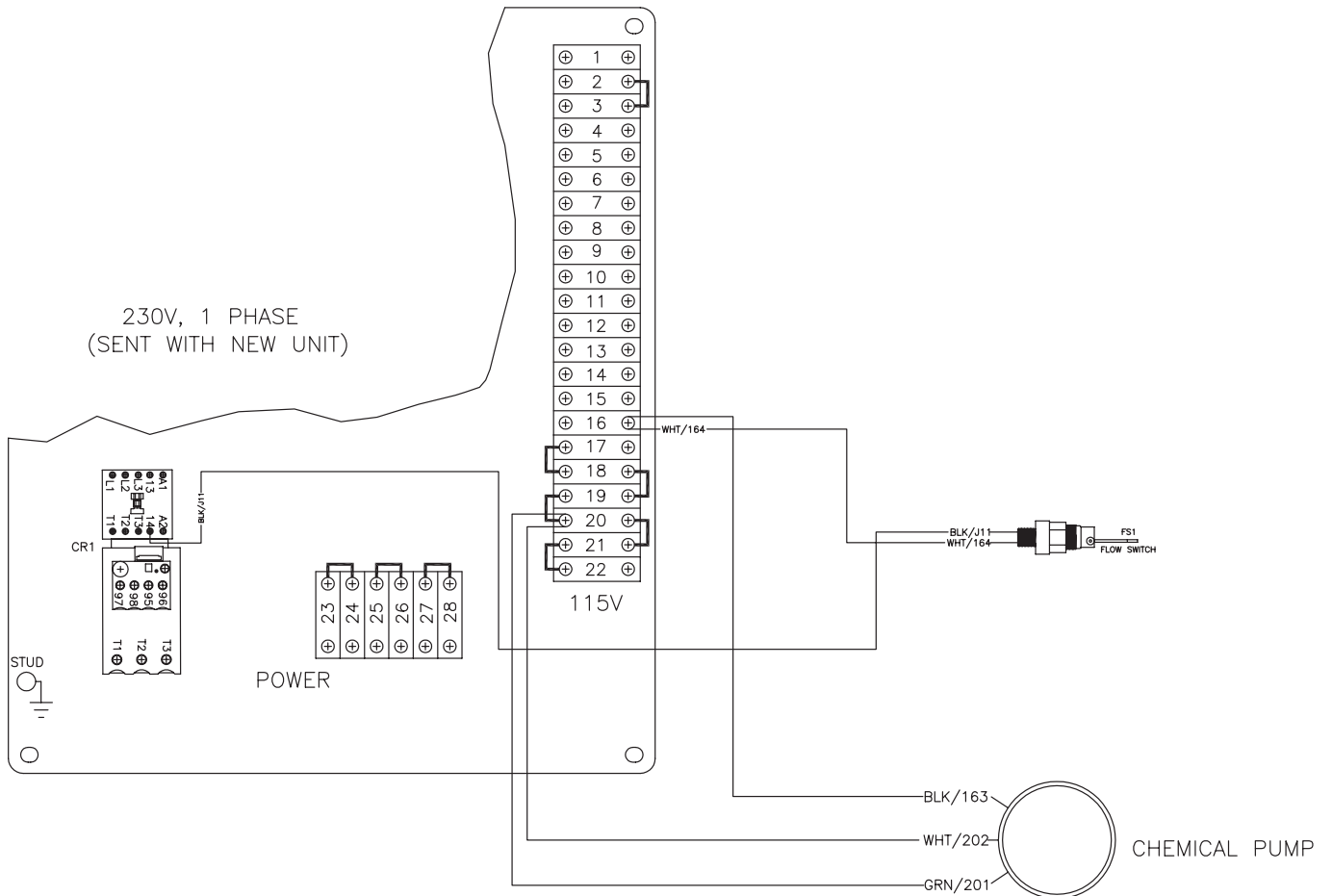
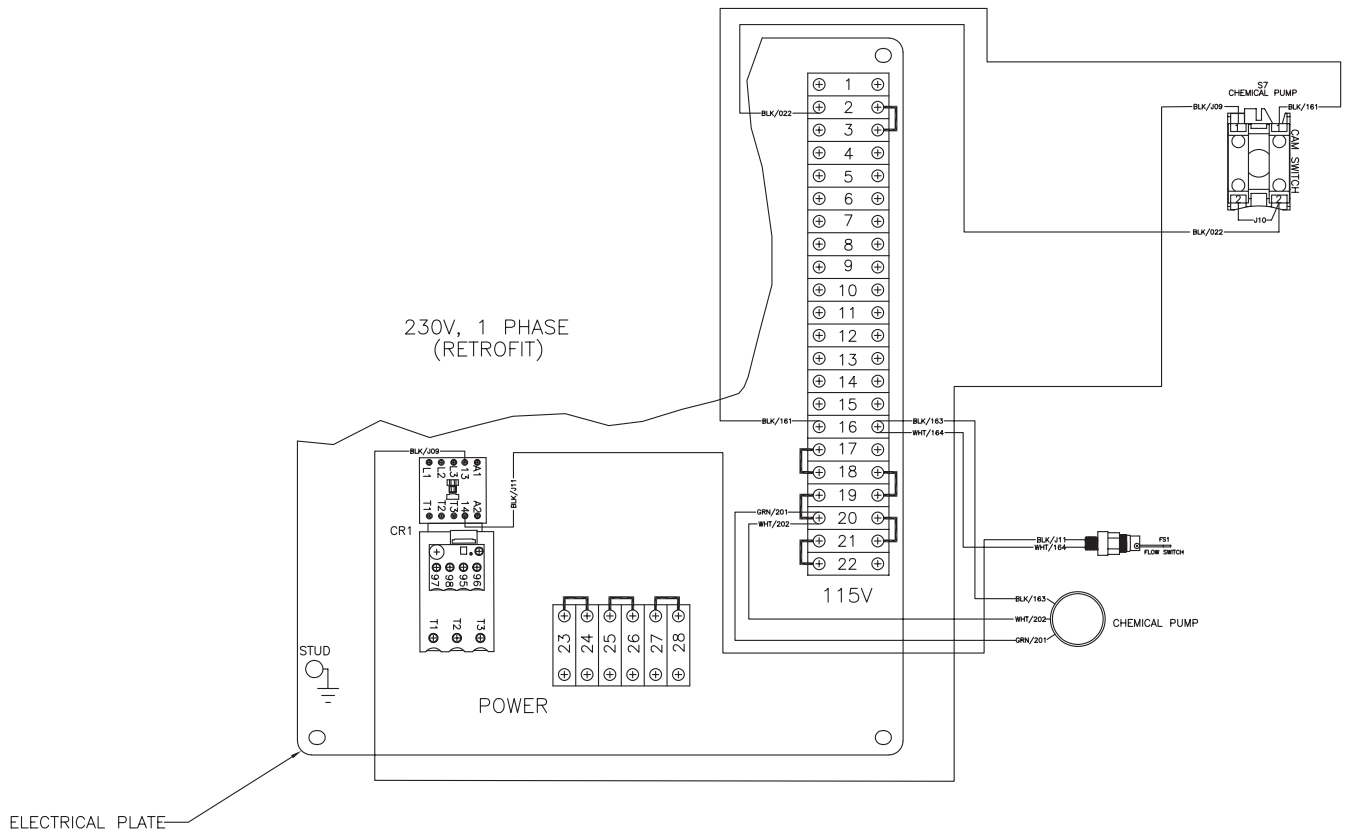

INSTALLATION

1. Instructions for installing coagulant addition system.

a. Plumbing: The coagulant addition system comes with 3 main sections of plumbing separated by unions. If ordered with a WTA settling tank the plumbing will come installed from the factory and assembly of the coagulant addition system is already complete. If adding to a different settling tank, the plumbing will need to be adjusted so an extra length of pipe will be provided to adjust height and length as needed. See features drawing and parts breakdown for reference and make sure plumbing is properly supported. The plumbing should usually run about 6" to the top of the settling tank but this might change depending on the tank used.

b. Plumbing Connections:

- Connect plumbing from the sump pump (provided with Biological unit) to the 1-1/2" FPT fitting on the inlet of the coagulant addition system. (Follow guidelines in Biological unit installation instructions for pipe size and check valve requirements).
- Run plumbing from the outlet of the WTA or settling tank to additional tanks or the inlet of the biological unit.

c. Electrical:

- **(ONLY if adding to existing biological unit in the field, new biological units will come with selector switch already wired and installed):** A 3-way selector switch, decal and cartridges will be shipped separately with the unit. Install the switch, decal and back cartridges onto the front of the biological unit control panel. Usually a location on the bottom right front of the panel will provide enough room for the backside of the switch inside the panel. The switch requires a 22.5 mm hole. Consult wiring diagram on previous page for wiring additions to the biological unit. A strain relief will also need to be installed in the bottom of the panel for the pump cord. (Some older/custom units will require different wiring, consult factory with questions).
- A 20ft. cord is supplied with the coagulant pump. Run this cord to the biological unit control panel and wire into the control box as shown in the following field wiring diagram. (An open strain relief is provided in the bottom of the control panel).

d. Chemical Hoses and Container:

- **Suction hose:** The suction hose is the clear softer hose connected to the bottom of the pump. Place this hose assembly, with ceramic weight and strainer on the end into the coagulant chemical container. The strainer should be kept about an inch off the bottom of the container.
- **Discharge hose:** The discharge hose is the slightly opaque, firmer hose connected to the top of the pump. Ensure the other end of the hose is connected to the injection valve located after the gate valve on the inlet plumbing. Connect using the tube nuts provided on the injection valve.

2. Preparation for coagulant addition system: (Follow all guidelines for preparing the biological system in its manual as well as the guidelines below).

a. Coagulant selection: There are a variety of coagulants used in waste water treatment. The waste water characteristics will determine the best coagulant to use in each application. Aluminum Sulfate (Alum) is one of the most widely used and works well in most applications. For this reason this is the recommended chemical to use with the coagulant addition system. Other potential coagulants that could be used are Poly aluminum chloride (PAC), ferric chloride, ferric sulfate, and calcium chloride.

Aluminum sulfate can be purchased in dry or solution form, in most applications a 5%-10% w/v solution is sufficient. Other concentrations can be used and dosing will need to be adjusted accordingly. See table below for the dry aluminum sulfate amount required for creating a specific solution. A 55 gallon drum or larger is recommended.

lbs Alum	Weight/Volume % of final solution for 55 gallon drum
23	5
46	10
69	15
92	20
115	25

3. Operation of coagulant addition system:

a. Start up: Follow guidelines in the biological system manual. Use inlet flow control valve and flow meter to set the flow on the coagulant addition system. 20-30GPM is the recommended flow rate in most cases. On initial start-up the flow meter will need to have the air removed by loosening the cap until the air is purged. The flowrate affects the coagulant dose required and should be kept constant. If it is adjusted the coagulant dose will need to be adjusted as well.

INSTALLATION

b. 3-way selector switch settings (located on biological unit control panel):

- **Off:** Coagulant Pump is off.
- **Manual:** Coagulant Pump will run continuously, used for priming.
- **Auto:** Coagulant Pump will automatically run when the biological unit's sump pump is on. This is the operation mode setting.

c. **Priming the coagulant pump:** With the strainer placed in the coagulant container, turn the 3-way selector switch to the manual setting. The pump will turn on and begin pumping coagulant through the hoses. Once the chemical hose inlet line and outlet line are full of coagulant, shut selector switch to off.

d. **Coagulant Dosing:** The proper coagulant dose is vital to its effectiveness. Dosing too little or too much coagulant will have little to no effect on the wastewater. The correct dosage will be affected by water flow rate, coagulant concentration, and the characteristics of the waste water. The dosage rate of the coagulant pump can be adjusted using the knob on the pump head.

- **Adjusting coagulant pump output:**

aa 1. Shut pump off before adjusting.

2. Remove the clear cover that protects the dial.

3. Loosen the wing nut.

4. Turn the adjustable knob so the pointer is on the required setting.

5. Hold the knob in place while tightening the wing nut.

- **Coagulant pump output based on dial setting:** The below chart shows the estimated pump output based on the dial setting.

Approximate Pump flow rate based on knob setting	
Pump setting	GPH (Gallons per Hour)
0-1.0	0-.08
1.0	0.08
1.5	0.80
2.0	1.45
2.5	2.03
3.0	2.54
3.5	2.99
4.0	3.36
4.5	3.66
5.0	3.90
5.5	4.06
6.0	4.20
>6.0	4.20-4.6

There are two methods that can be used to determine the correct dosing rate; Trial and Error and Jar Testing.

- **Trial and error method:**

1. First obtain a pure waste water sample that has no coagulant for comparisons from the pit or sampling valve.

2. Start with the coagulant pump on the 2 dial setting. (In most cases this is the lowest setting that can be effective).

3. Turn the 3-way selector switch to the Auto setting; coagulant pump will now turn on when the sump pump turns on.

4. With waste water flowing into the system and operational flow rate set, use the sampling valve to fill a clear container or jar with water. A 1L container is usually sufficient.

5. Stir the sample for about 10 seconds and let sit for 10 minutes.

6. After 10 minutes check for visible signs of separation and "floc" formation and compare to the pure waste water sample.

INSTALLATION

7. Repeat procedure at various dial settings as needed, select the lowest setting that results in good settling performance.

• **Jar Testing Method:**

1. Use 4 or 5 1L beakers or a similar sized clear container that has volume markings.
2. Fill all the beakers with wastewater from the sampling valve or directly from the pit to a known volume.
3. Using a small graduated cylinder measure out incremental quantities of coagulant to add to each beaker. For 1000 ml of water and a 5-10% coagulant solution typically between 1-5 mL is a good testing range.
4. Add 1mL of coagulant to the first beaker, 2ml to the 2nd, and so on up to 5 mL in the 5th beaker. (Depending on waste-water and coagulant strength other volumes of coagulant might need to be tested as well).
5. Use a stirrer to stir each beaker for about 10 seconds each. Let the beakers sit about 10 minutes.
6. After the sitting time analyze each beaker. Select the best dose by determining which beaker exhibited good settling with the smallest amount of coagulant. The dosing ratio will be the amount of coagulant used divided by the volume of water. (If no beakers exhibit a change in settling performance other volumes of coagulant or a different coagulant will need to be tried).
7. Determine the coagulant pump flow rate that will match the dosing ratio selected from jar testing using the equation

$$\text{Pump (GPH)} = \text{Dosing ratio} * \text{Water flow rate (GPM)} * 60$$

EXAMPLE:

- a. 2mL of coagulant was determined to be the best dose for a 1000 mL jar test.
- b. The inlet waste water flow is set at a constant 25 GPM.

$$\text{Pump (GPH)} = 2\text{mL}/(1000 \text{ mL}) * 25\text{GPM} * 60 = 3 \text{ GPH}$$

8. Set coagulant pump to the calculated flow rate by adjusting the dial setting. See chart on previous page for corresponding flow rates based on knob setting and select the closest knob position. For the example the pump knob in this case would be set to about 3.5.

- e. **Continuous Operation:** After knob is set in the ideal position, the system is ready for continuous operation. The 3-way selector switch will need to be set to the Auto position. As the sump pump turns on to pump waste water to the settling tank, the coagulant pump will automatically run, adding coagulant to the incoming flow stream. Periodically verify that the coagulant dose is correct by obtaining a sample from the sample port when the sump pump is in operation. Adjust dosage as needed by using the trial and error or jar testing method.
 - f. **Shut Down:** To stop the coagulant pump from automatically running with the sump pump, turn the 3-way selector switch to Off. In some set-ups the biological unit is set-up to continuously recirculate, this means that during non-wash times the sump pump will periodically turn on as the pit slowly fills from recirculated water. To lower coagulant use in these set-ups the 3-way selector switch can be set to Off during non-wash times.
4. **Maintenance: Follow procedures for maintaining the biological unit in the biological system manual. In addition for the coagulant addition system:**
- a. **Weekly:**
 - Verify correct dosing rates by obtaining a wastewater sample from the sampling port.
 - Check level of coagulant available in container, add more coagulant as needed.
 - Check inlet flow meter is reading close to the original flow rate. If the float has changed significantly clean flow meter or purge flow meter of air and adjust inlet valve back to set flow rate.
 - Dump solids from cone bottom tank if no automatic dumping system is installed.
 - b. **Monthly:**
 - Check chemical hose for signs of wear and blockage.
 - Remove injection valve and clean if needed.
 - Check/clean bullet valves on chemical pump.

INSTALLATION

c. Yearly:

- Pump clean water through the plumbing line to help remove built up solids and debris from flow meter, mixer, and valves.
- Pump clean water through the coagulant hoses and pump, to clean anything built up in the line.

5. Winterizing: Follow winterizing procedure that is outlined in the biological unit manual. Drain all inlet plumbing and coagulant pump of fluid.

6. Troubleshooting:

Symptom	Probable Cause	Remedy
Coagulant pump will not turn on.	No power available.	Make sure biological unit master switch is on. Review wiring diagrams and troubleshooting instructions in biological unit manual.
	3-way selector switch is set to off.	Set 3-way selector switch to manual or auto setting.
	Sump pump is off, 3-way selector switch is set to auto.	Review trouble shooting instructions in biological unit manual.
	Flow switch is not engaging.	Ensure sump pump is on. Increase Flow, Clean Flow Switch, or replace Flow switch.
Coagulant pump is on but not pumping chemical.	Strainer not submerged in coagulant.	Adjust strainer inside coagulant container or add more coagulant.
	Blockage in hose or pump bullet valves.	Clean hose and bullet valves with clean water.
Flow meter reading 0 or low.	Sump pump is off.	Review troubleshooting instructions in biological unit manual.
	Inlet gate valve is closed.	Open gate valve to desired flow rate.
	Float is fouled.	Clean flow meter.
	Trapped air in flow meter.	Loosen cap to let air out.
Poor settling performance.	Poor coagulant choice.	Switch to a different coagulant.
	Too much or too little dosing.	Review dosing instructions and re-adjust pump flow rate as needed.
	Too little settling time.	Adjust sump pump flow rate or floats so sump pump cycles less frequently.

MAIN ASSEMBLY WTA-300/600

TURN ELBOW HORIZONTALLY SO WATER MOVES IN A CIRCLE

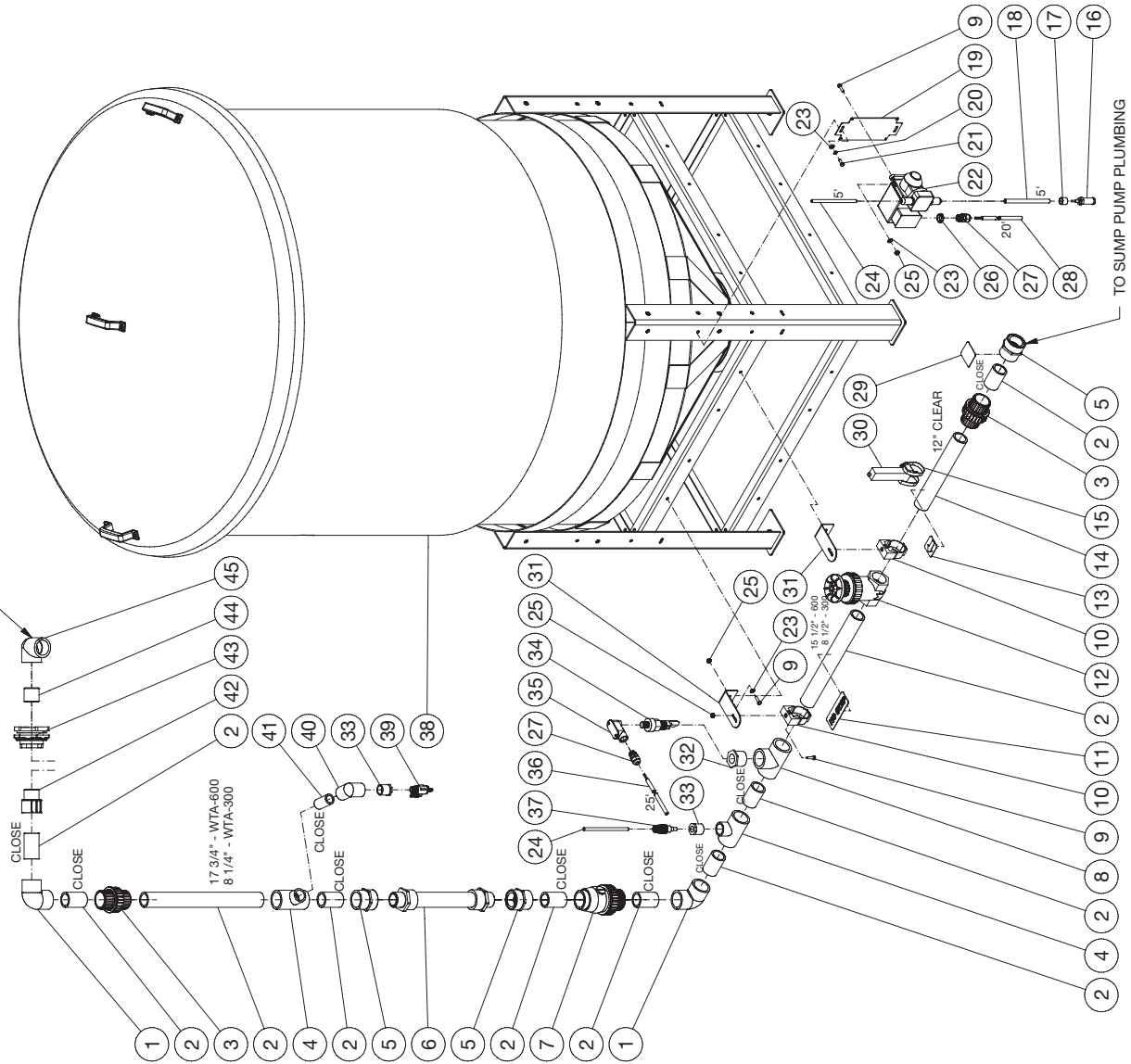

MAIN ASSEMBLY											
ITEM	DESCRIPTION	PART #	QTY	ITEM	DESCRIPTION	PART #	QTY	ITEM	DESCRIPTION		
1	ELBOW	55-1609	2	24	HOSE	15-0373	2	24	HOSE		
2	*PIPE 1 1/2" *(FIVE FEET REQUIRED)	55-1600	1	25	NUT	30-5202	6	25	NUT		
3	UNION - INCLUDES O-RING (25-0448)	55-1645	2	26	ELECTRICAL LOCKNUT	32-0108	1	26	ELECTRICAL LOCKNUT		
4	TEE	55-1603	2	27	STRAIN RELIEF	32-0437	2	27	STRAIN RELIEF		
5	FEMALE ADAPTER	55-1621	3	28	CORD *(TWENTY FEET REQUIRED)	32-0074	1	28	CORD *(TWENTY FEET REQUIRED)		
6	STATIC MIXER	55-1684	1	29	DECAL - INLET (SEE 71-XXXX)	N/A	1	29	DECAL - INLET (SEE 71-XXXX)		
7	CHECK VALVE	55-1652	1	30	FLOW METER	55-0016	1	30	FLOW METER		
8	TEE	55-1601	1	31	CLAMP BRACKET	20-0555A01	2	31	CLAMP BRACKET		
9	BOLT	27-8962	6	32	REDUCER	55-1629	1	32	REDUCER		
10	CLAMP	42-0026	2	33	REDUCER	55-1229	2	33	REDUCER		
11	DECAL	N/A	1	34	FLOW SWITCH	32-0641	1	34	FLOW SWITCH		
12	GATE VALVE	55-1671	1	35	ELBOW	32-0642	1	35	ELBOW		
13	DECAL	N/A	1	36	CORD *(TWENTY FIVE FEET REQUIRED)	32-0075	1	36	CORD *(TWENTY FIVE FEET REQUIRED)		
14	*PIPE 1 1/2" CLEAR *(ONE FOOT REQUIRED)	55-1685	1	37	VALVE	55-0127	1	37	VALVE		
15	HOSE CLAMP	42-0027	2	38	TANK ASSEMBLY	N/A SEP.	1	38	TANK ASSEMBLY		
16	STRAINER	19-0291	1	39	BALL VALVE	55-0889	1	39	BALL VALVE		
17	SPACER	33-0206	1	40	ELBOW	55-1209	1	40	ELBOW		
18	CLEAR TUBE	15-0374	1	41	*PIPE 1" *(ONE FOOT REQUIRED)	55-1200	1	41	*PIPE 1" *(ONE FOOT REQUIRED)		
19	SUPPORT PLATE	20-1283A01	1	42	ADAPTER	55-1622	1	42	ADAPTER		
20	LOCKWASHER	29-1006	2	43	BULKHEAD (INC. 25-0481 GASKET)	55-1686	1	43	BULKHEAD (INC. 25-0481 GASKET)		
21	BOLT	27-5016	2	44	NIPPLE	55-1674	1	44	NIPPLE		
22	CHEMICAL PUMP	3-0435	1	45	ELBOW	55-1610	1	45	ELBOW		
23	WASHER	28-0121	6	*MUST ORDER IN ONE FOOT LENGTHS						45	ELBOW

WX-0133 032318 MLK

PUMP ASSEMBLY 3-0435

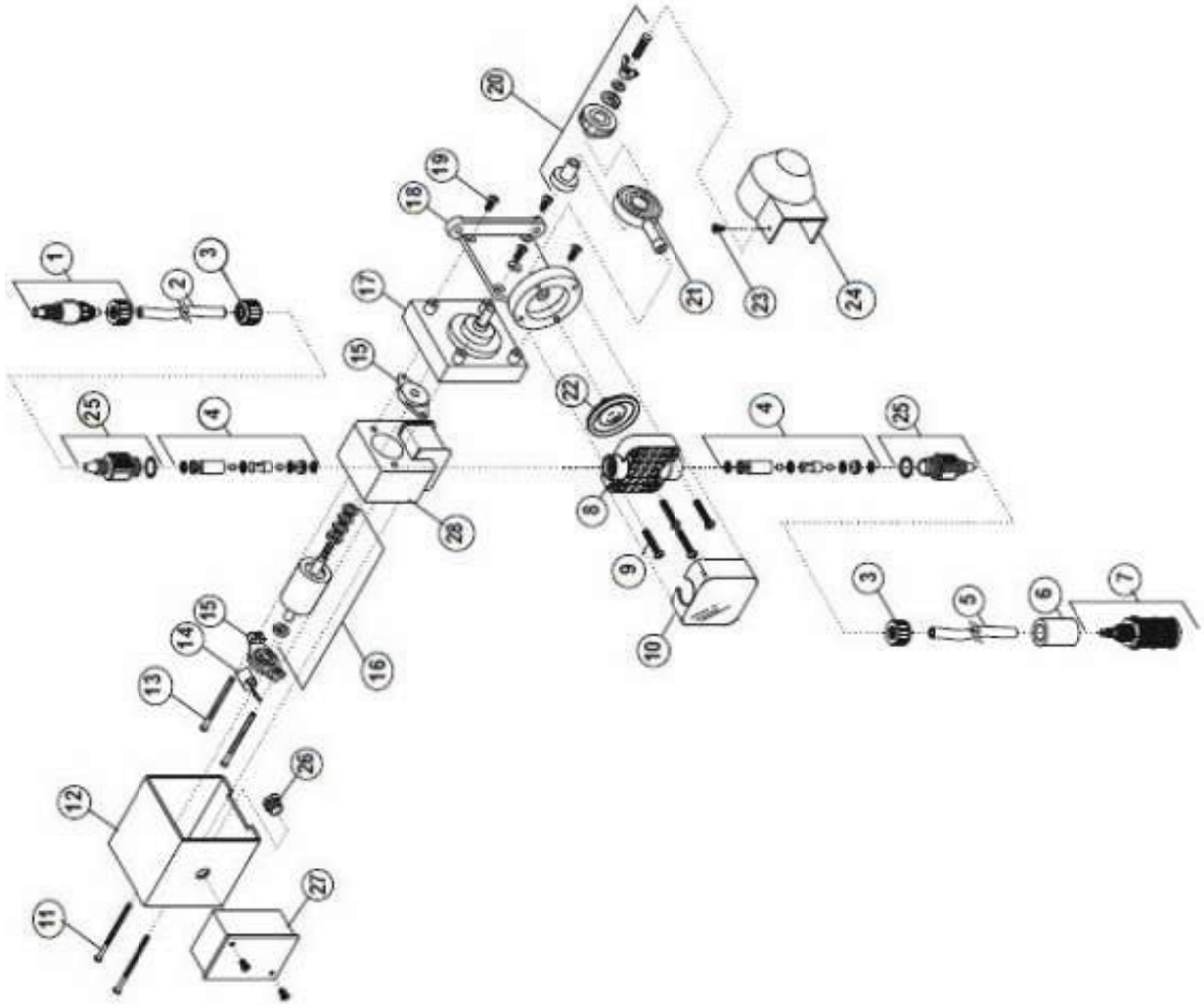

PUMP ASSEMBLY						
ITEM	DESCRIPTION	PART #	QTY	ITEM	DESCRIPTION	PART #
1	INJECTION VALVE, AFLAS	55-0127	1	-	GEARBOX ASSEMBLY, 60 RPM	N/A
-	INJECTION VALVE, EP (OPTIONAL)	N/A	1	-	GEARBOX ASSEMBLY, 125 RPM	N/A
2	DISCHARGE TUBING 3/8 OD	15-0373	1	-	GEARBOX ASSEMBLY, 250 RPM	N/A
3	TUBE NUT	46-1682	2	18	MOTOR MOUNT	N/A
4	BULLET VALVE, AFLAS, 4 PACK SET	46-1683	2	19	MOTOR MOUNT SCREW	N/A
-	BULLET VALVE, AFLAS, 10 PACK SET	N/A	2	20	CAM	N/A
-	BULLET VALVE, EP, 4 PACK SET (OPTIONAL)	N/A	2	21	YOKE W/BEARING	N/A
-	BULLET VALVE, EP, 10 PACK SET (OPTIONAL)	N/A	2	22	DIAPHRAGM PTFE COATED, EP	46-1684
5	SUCTION TUBING, 3/8" OD	15-0374	1	23	SCREW	N/A
6	CERAMIC WEIGHT	33-0609	1	24	CAM COVER	N/A
7	FOOT VALVE/STRAINER, AFLAS	19-0291	1	25	BULLET VALVE ADAPTER, EP O-RING	46-1685
-	FOOT VALVE/STRAINER, EP (OPTIONAL)	N/A	1	26	1/2" ALUMINUM CHASE NIPPLE	N/A
8	PUMP HEAD	N/A	1	27	JUNCTION BOX COMPLETE W/COVER AND GASKET	N/A
9	SCREW	N/A	4	28	STATOR S/A 115V/60HZ, BLUE-BLACK (LEAD WIRES)	N/A
10	PUMP HEAD COVER	N/A	1	-	STATOR S/A 230V/60HZ, RED-BLACK (LEAD WIRES)	N/A
11	COVER SCREW	N/A	2	-	STATOR S/A 220V/50HZ, BROWN-BLUE (LEAD WIRES)	N/A
12	MOTOR COVER	N/A	1	-	STATOR S/A 24V/60HZ, BLUE-WHITE (LEAD WIRES)	N/A
13	MOTOR SCREW	N/A	2	-	STATOR S/A 24V/50HZ, WHITE-WHITE (LEAD WIRES)	N/A
14	ROTOR FAN	N/A	1	-	STATOR S/A 230V/60HZ, RED-YELLOW (LEAD WIRES)	N/A
15	ROTOR BEARING	N/A	2	-	STATOR S/A 220V/50HZ, BROWN-YELLOW (LEAD WIRES)	N/A
16	ROTOR W/SPACER	N/A	1	-	STATOR S/A 115V/60HZ, BLUE-YELLOW (LEAD WIRES)	N/A
17	GEARBOX ASSEMBLY, 14 RPM	N/A	1	-	STATOR S/A 240V/50HZ, ORANGE-YELLOW (LEAD WIRES)	N/A
-	GEARBOX ASSEMBLY, 30 RPM	N/A	1	-	STATOR S/A 240V/50HZ, ORANGE-WHITE (LEAD WIRES)	N/A
-	GEARBOX ASSEMBLY, 45 RPM	N/A	1	-		

3-0435 013023

WIRING SCHEMATIC SINGLE PHASE

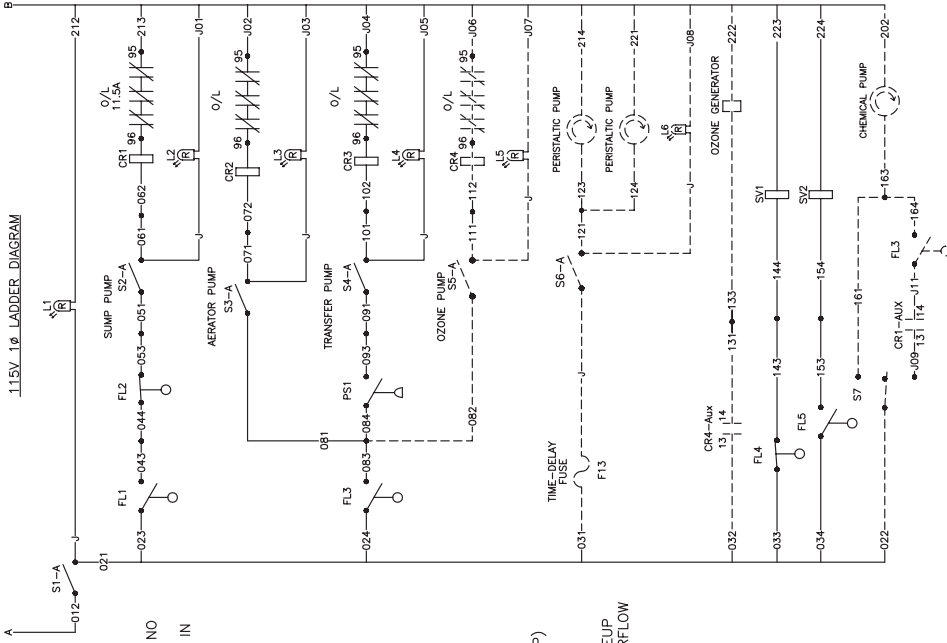

NOTES:
 1) LADDER DIAGRAM SHOWN WITH POWER TO UNIT AND NO WATER IN PIT
 2) ALL WIRES ARE 16GA UNLESS OTHERWISE SPECIFIED IN THE TABLE BELOW.

LEGEND

- CR1 = CONTROL RELAY, SUMP PUMP
- CR2 = CONTROL RELAY, AERATOR PUMP
- CR3 = CONTROL RELAY, TRANSFER PUMP
- CR4 = CONTROL RELAY, OZONE PUMP
- S1 = SWITCH, MASTER
- S2 = SWITCH, SUMP PUMP
- S3 = SWITCH, AERATOR PUMP
- S4 = SWITCH, TRANSFER PUMP
- S5 = SWITCH, OZONE SYSTEM
- S6 = SELECTOR SWITCH, CHEMICAL PUMP
- L1 = LIGHT; FOR S1
- L2 = LIGHT; FOR S2
- L3 = LIGHT; FOR S3
- L4 = LIGHT; FOR S4
- L5 = LIGHT; FOR S5
- L6 = LIGHT; FOR S6
- PS1 = PRESSURE SWITCH, 30-50 PSI (TRANSFER PUMP)
- FL1 = FLOAT, N.O. BLUE LOW LEVEL (SUMP PIT)
- FL2 = FLOAT, N.C. HIGH LEVEL (PRODUCT TANK)
- FL3 = FLOAT, N.O. GREEN LOW LEVEL (PRODUCT TANK)
- FL4 = FLOAT, N.C. RED LOW LEVEL FRESH WATER MAKEUP
- FL5 = FLOAT, N.O. GREEN HIGH LEVEL RAINWATER OVERFLOW
- SV1 = SOLENOID VALVE, FRESH WATER MAKEUP
- SV2 = SOLENOID VALVE, RAINWATER OVERFLOW

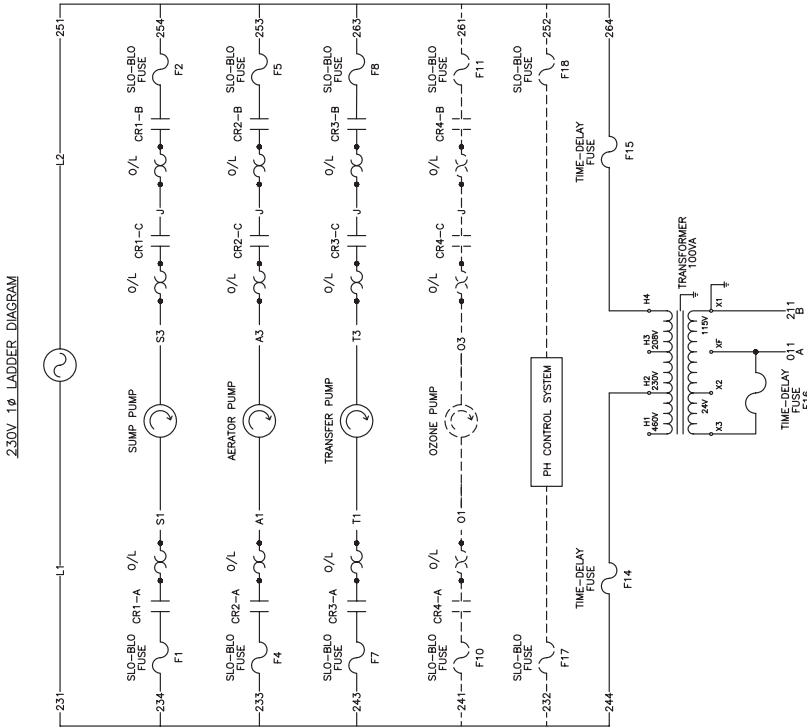

LADDER DIAGRAM - MASTER - BIO-20R, 25R, 35R - 1 PHASE 091616

WIRING DIAGRAM SINGLE PHASE

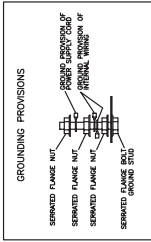
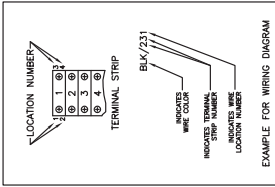
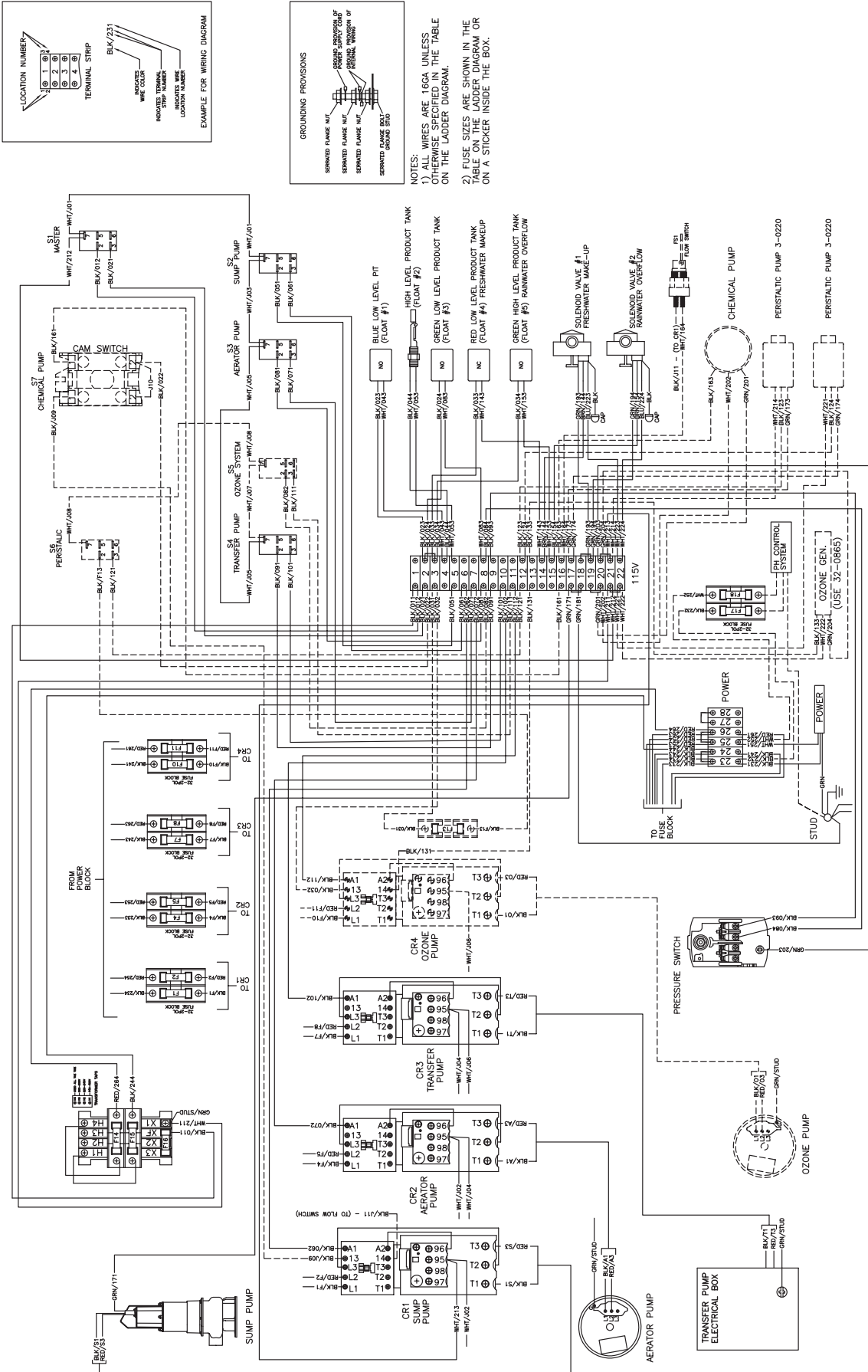

NOTES:
 1) ALL WIRES ARE 16GA UNLESS OTHERWISE SPECIFIED IN THE TABLE ON THE LADDER DIAGRAM.
 2) FUSE SIZES ARE SHOWN IN THE TABLE ON THE LADDER DIAGRAM OR ON A STICKER INSIDE THE BOX.

WIRING SCHEMATIC THREE PHASE

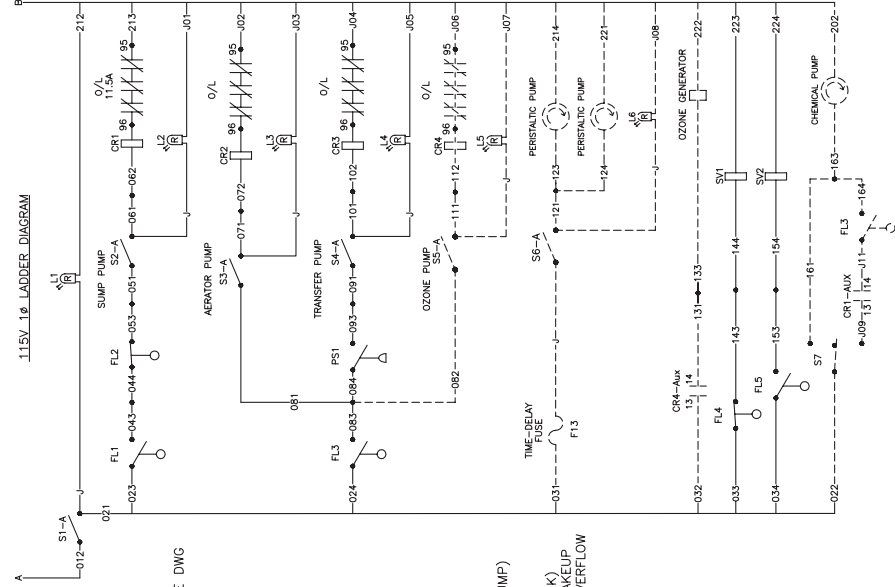
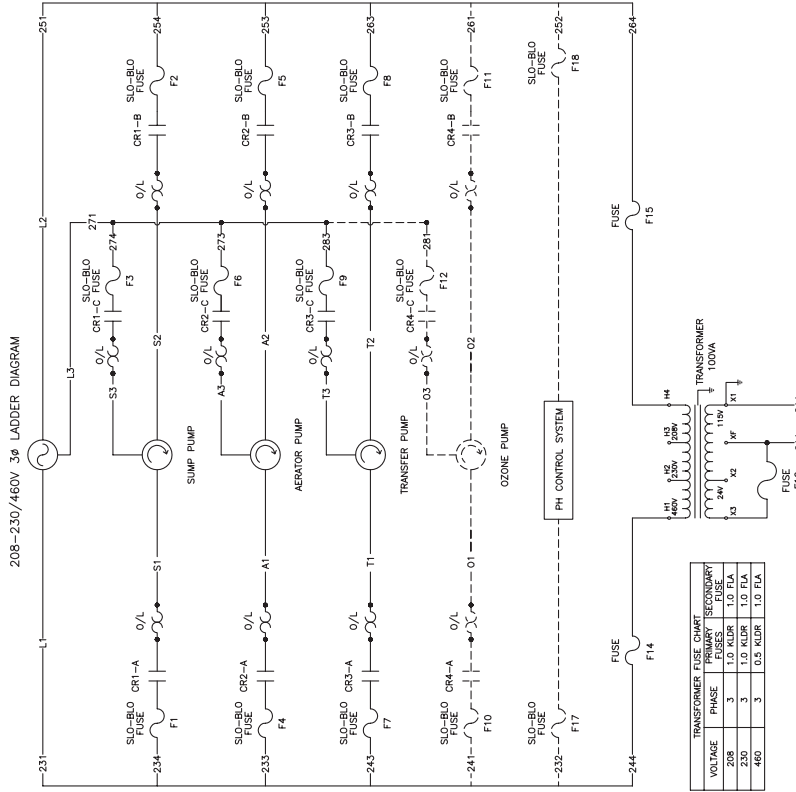

NOTE: REFER DIAGRAM SHOWN WITH POWER TO UNIT AND NO WATER IN PIT FOR FUSE AND OVERLOAD SETTINGS SEE: FUSE AND OVERLOAD SETTINGS MASTER 3 PHASE DWG

- LEGEND
- CR1 = CONTROL RELAY, SUMP PUMP
 - CR2 = CONTROL RELAY, AERATOR PUMP
 - CR3 = CONTROL RELAY, TRANSFER PUMP
 - CR4 = CONTROL RELAY, OZONE PUMP
 - S1 = SWITCH, SUMP PUMP
 - S2 = SWITCH, AERATOR PUMP
 - S3 = SWITCH, TRANSFER PUMP
 - S4 = SWITCH, OZONE SYSTEM
 - S5 = SWITCH, PERISTALTIC PUMP
 - S6 = SWITCH, PERISTALTIC PUMP
 - S7 = SELECTOR SWITCH, CHEMICAL PUMP
 - L1 = LIGHT, FOR S1
 - L2 = LIGHT, FOR S2
 - L3 = LIGHT, FOR S3
 - L4 = LIGHT, FOR S4
 - L5 = LIGHT, FOR S5
 - L6 = LIGHT, FOR S6
 - L7 = LIGHT, FOR S7
 - PS1 = PRESSURE SWITCH, 30-50 PSI (TRANSFER PUMP)
 - FL1 = FLOAT, N.O. BLUE LOW LEVEL (SUMP PIT)
 - FL2 = FLOAT, N.C. HIGH LEVEL (PRODUCT TANK)
 - FL3 = FLOAT, N.O. GREEN LOW LEVEL (PRODUCT TANK)
 - FL4 = FLOAT, N.O. GREEN LOW LEVEL (FRESH WATER MAKEUP)
 - FL5 = FLOAT, N.O. GREEN HIGH LEVEL (RAINWATER OVERFLOW)
 - SV1 = SOLENOID VALVE, FRESH WATER MAKEUP
 - SV2 = SOLENOID VALVE, RAINWATER OVERFLOW



STATEMENT OF WARRANTY

Mi-T-M warrants all parts (except those referred to below) of your new coagulant addition system to be free from defects in materials and workmanship for one year from the date of original purchase.

Defective parts not subject to normal wear and tear will be repaired or replaced at Mi-T-M's option during the warranty period. In any event, reimbursement is limited to the purchase price paid.

EXCLUSIONS

1. The motor is covered under separate warranty by its respective manufacturer and is subject to the terms set forth therein.
2. Normal wear parts:

Seals	Filters	Gaskets
O-rings	Packings	Pistons
Valve Assembly	Brushes	Filtering Media
Sensors		
3. Parts damaged due to:
 - normal wear, misapplication, modifications/alterations, abuse,
 - operation at other than recommended speeds, pressures or temperature,
 - the use of caustic liquids,
 - chloride corrosion or chemical deterioration,
 - fluctuations in electrical or water supply,
 - operating unit in an abrasive, corrosive or freezing environment.
4. Parts damaged by failure to follow recommended:
 - installation, operating and maintenance procedures.
5. This warranty does not cover the cost of:
 - normal maintenance or adjustments,
 - labor charges,
 - transportation charges to Service Center,
 - freight damage.
6. The use of other than genuine Mi-T-M parts will void warranty. Parts returned, prepaid to Mi-T-M's factory or to an Authorized Service Center will be inspected and replaced free of charge if found to be defective and subject to warranty. There are no warranties which extend beyond the description of the face hereof. Under no circumstances shall Mi-T-M bear any responsibility for loss of use of the unit, loss of time or rental, inconvenience, commercial loss or consequential damages.

Manufactured by Mi-T-M
50 Mi-T-M Drive, Peosta IA 52068
563-556-7484/ Fax 563-556-1235